

FM-753[®] CRACK

HEAVY DUTY THROUGH ANCHOR WITH SEISMIC CERTIFICATION

ICCONS[®]

Serious Connections[®]



Maximum performance, with seismic certification C2.

SOLID EXPANSION

Stainless steel clip
with propriety design



GREATER STABILITY

Nine gripping dents
for undercutting
action into concrete



NAUTILUS

1000 h

Special anti-corrosion coating
1000 hours in salt spray test



APPLICATIONS:

Steel/Aluminium constructions which require
a high certified level of safety

- Suspended applications
- Data centres & high risk applications
- Heavy duty machinery
- Airports & transport infrastructure
- Structural applications in seismic areas
- Bridging & tunnelling
- Public infrastructure

www.iccons.com.au

FM-753[®] CRACK

Heavy duty through anchor for use in seismic zones

▶ FM-753[®] CRACK NAUTILUS

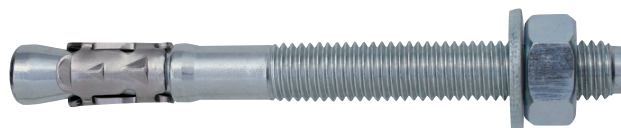
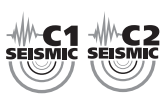

Assembled Hardened and tempered anchor body
Stainless steel A4 clip

NAUTILUS **1000 h**
Special anti-corrosion coating with glossy finish
1000 hours in salt spray test

Seismic certification category
C1
For non-structural use

Seismic certification category
C2
For structural and non-structural use

OPTION 1
For cracked concrete

GAL

Part No.	Description	mm	Clearance mm	mm	Thread mm	Socket mm	qty	qty
FM753C08068G (75350b08068)	M8x68	8	9	4	30	13	100	400
FM753C08075G (75350b08075)	M8x75	8	9	10	30	13	100	400
FM753C08090G (75350b08090)	M8x90	8	9	25	40	13	100	400
FM753C08115G (75350b08115)	M8x115	8	9	50	60	13	100	400
FM753C08135G (75350b08135)	M8x135	8	9	70	80	13	100	400
FM753C08165G (75350b08165)	M8x165	8	9	100	80	13	50	200
FM753C10090G (75350b10090)	M10x90	10	12	10	40	17	50	200
FM753C10105G (75350b10105)	M10x105	10	12	25	55	17	50	200
FM753C10115G (75350b10115)	M10x115	10	12	35	55	17	50	200
FM753C10135G (75350b10135)	M10x135	10	12	55	85	17	50	200
FM753C10155G (75350b10155)	M10x155	10	12	75	85	17	50	200
FM753C10185G (75350b10185)	M10x185	10	12	105	85	17	25	100
FM753C12110G (75350b12110)	M12x110	12	14	10	65	19	50	200
FM753C12120G (75350b12120)	M12x120	12	14	20	65	19	50	200
FM753C12145G (75350b12145)	M12x145	12	14	45	85	19	25	100
FM753C12170G (75350b12170)	M12x170	12	14	70	85	19	25	100
FM753C12200G (75350b12200)	M12x200	12	14	100	85	19	25	100
FM753C16130G (75350b16130)	M16x130	16	18	10	65	24	20	80
FM753C16150G (75350b16150)	M16x150	16	18	30	85	24	20	80
FM753C16185G (75350b16185)	M16x185	16	18	60	85	24	20	80
FM753C16220G (75350b16220)	M16x220	16	18	100	85	24	15	60

▶ FM-753[®] CRACK - INOX A4 - 316SS

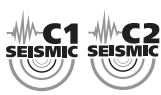

Assembled
Stainless steel A4 - 316SS

Seismic certification category
C1
For non-structural use

Seismic certification category
C2
For structural and non-structural use

OPTION 1
For cracked concrete

316 SS

Part No.	Description	mm	Clearance mm	mm	Thread mm	Socket mm	qty	qty
FM753C08068SS (75350008068)	M8x68	8	9	4	30	13	100	400
FM753C08075SS (75350008075)	M8x75	8	9	10	30	13	100	400
FM753C08090SS (75350008090)	M8x90	8	9	25	40	13	100	400
FM753C08115SS (75350008115)	M8x115	8	9	50	60	13	100	400
FM753C08135SS (75350008135)	M8x135	8	9	70	80	13	100	400
FM753C08165SS (75350008165)	M8x165	8	9	100	80	13	50	200
FM753C10090SS (75350010090)	M10x90	10	12	10	40	17	50	200
FM753C10105SS (75350010105)	M10x105	10	12	25	55	17	50	200
FM753C10115SS (75350010115)	M10x115	10	12	35	55	17	50	200
FM753C10135SS (75350010135)	M10x135	10	12	55	85	17	50	200
FM753C10155SS (75350010155)	M10x155	10	12	75	85	17	50	200
FM753C10185SS (75350010185)	M10x185	10	12	105	85	17	25	100
FM753C12110SS (75350012110)	M12x110	12	14	10	65	19	50	200
FM753C12120SS (75350012120)	M12x120	12	14	20	65	19	50	200
FM753C12145SS (75350012145)	M12x145	12	14	45	85	19	25	100
FM753C12170SS (75350012170)	M12x170	12	14	70	85	19	25	100
FM753C12200SS (75350012200)	M12x200	12	14	100	85	19	25	100
FM753C16130SS (75350016130)	M16x130	16	18	10	65	24	20	80
FM753C16150SS (75350016150)	M16x150	16	18	30	85	24	20	80
FM753C16185SS (75350016185)	M16x185	16	18	60	85	24	20	80
FM753C16220SS (75350016220)	M16x220	16	18	100	85	24	15	60

VERSIONS:

- NAUTILUS special anti-corrosion coating
- stainless steel A4

PRODUCT FEATURES:

- hardened and tempered steel class 9.8 anchor body
- stainless steel A4 expander clip
- increased thickness of three expander segments
- nine gripping dents for keying effect into the concrete

SUITABLE BASE MATERIALS:

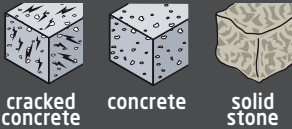

CERTIFICATIONS:

- Seismic certification C1 - C2
- OPTION 1: For cracked concrete
- F120 fire resistance certification

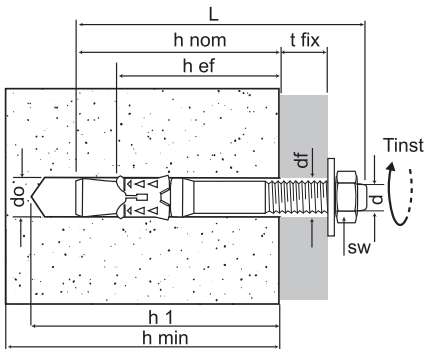
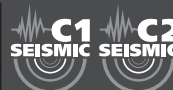

- d = anchor diameter
- do = hole diameter
- df = clearance hole in fixture
- tfix = fixture thickness
- sw = socket size
- L = anchor length
- h₁ = hef
- h_{ef} = minimum hole depth
- h_{min} = minimum depth of anchor
- h_{nom} = nominal embedment depth
- T_{inst} = torque

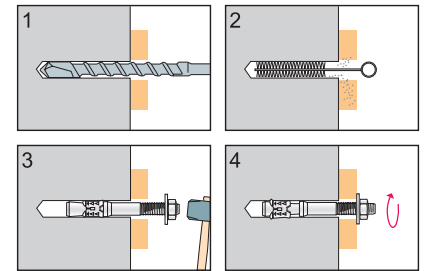

DESIGN⁽¹⁾ AND RECOMMENDED⁽²⁾ LOADS

Single anchor with large anchor spacing and edge distances in cracked and non-cracked concrete C20/25

Anchor		M8	M10	M12	M16		
Minimum support thickness	h _{min} mm	100	120	150	170		
Minimum hole depth	h ₁ mm	70	80	100	115		
Nominal embedment depth	h _{nom} mm	54	67	81	97		
Minimum depth of anchorage	h _{ef} mm	48	60	72	86		
Hole diameter	d ₀ mm	8	10	12	16		
Spacing	S _{cr,N} mm	140	180	220	260		
Edge distance	C _{cr,N} mm	70	90	110	130		
FM-753® CRACK NAUTILUS coating glossy finish ETA 09/0056	Tensile non-cracked concrete	N _{rd,ucr} kN	6,0	10,7	13,3	23,3	
		N _{ucr} kN	4,3	7,6	9,5	16,7	
	Tensile cracked concrete	N _{rd,cr} kN	4,0	8,0	10,7	13,3	
		N _{cr} kN	2,9	5,7	7,6	9,5	
	Shear ⁽³⁾	V _{rd} kN	8,6	16,1	22,5	44,3	
		V kN	6,1	11,5	16,1	31,6	
	Seismic Resistance Category C1	Tensile	N _{rd,seis C1} kN	4,0	8,0	10,7	13,3
			N _{seis C1} kN	2,9	5,7	7,6	9,5
		Shear ⁽³⁾	V _{rd,seis C1} kN	5,1	11,3	20,3	38,4
			V _{seis C1} kN	3,7	8,1	14,5	27,4
	Seismic Resistance Category C2	Tensile	N _{rd,seis C2} kN	-	2,2	7,9	13,3
			N _{seis C2} kN	-	1,6	5,6	9,5
Shear ⁽³⁾		V _{rd,seis C2} kN	-	7,9	12,9	20,8	
		V _{seis C2} kN	-	5,7	9,2	14,9	
Minimum spacing	S _{min} mm	50	60	70	80		
Minimum edge distance	for C mm	65	80	90	120		
	for S mm	75	120	150	170		
Shear C = C _{min}	V _{rd,cmin} kN	3,2	4,4	5,8	8,1		
	V _{cmin} kN	2,3	3,2	4,1	5,8		
FM-753® CRACK stainless steel A4 ETA 10/0293	Tensile non-cracked concrete	N _{rd,ucr} kN	6,0	10,7	13,3	23,3	
		N _{ucr} kN	4,3	7,6	9,5	16,7	
	Tensile cracked concrete	N _{rd,cr} kN	3,3	6,0	8,0	16,7	
		N _{cr} kN	2,4	4,3	5,7	11,9	
	Shear ⁽³⁾	V _{rd} kN	9,1	14,5	21,1	39,2	
		V kN	6,5	10,4	15,1	28,0	
	Minimum spacing	S _{min} mm	50	55	60	70	
		for C mm	50	70	80	100	
	Minimum edge distance	C _{min} mm	50	50	60	70	
		for S mm	50	110	120	130	
	Shear C = C _{min}	V _{rd,cmin} kN	3,2	3,5	4,7	6,3	
		V _{cmin} kN	2,3	2,5	3,4	4,5	
Torque	T _{inst} Nm	20	40	60	120		

⁽¹⁾ The design loads N_{rd} and V_{rd} derive from the characteristic loads on the ETA certification and are inclusive of the partial safety factors γ_m proportional to each diameter (see ETA).

⁽²⁾ The recommended loads N and V derive from the characteristic loads on the ETA certification and are inclusive of the partial safety factors γ_r=1.4 and γ_m proportional to each diameter (see ETA).

⁽³⁾ Shear values valid with distance from the edge C > 10 x h_{ef}

The load values are only valid if the installation has been carried out correctly. The design engineer is responsible for the designing and calculation of the fixing. The designing and calculation of the anchorage should be carried out in accordance with ETAG001-C or CEN/TS 1992/4 or under Seismic action acc.to TR045.

More products from ICCONS® seismic certified range

<p>▶ ATS-evo</p>			
<p>▶ BIS-PE PURE EPOXY</p>			
<p>▶ BIS-V VINYLESTER</p>			



ICCONS® PTY LTD

VICTORIA - HEAD OFFICE

12-18 Produce Drive, Dandenong South, Vic, 3175
P: 03 9706 4344
F: 03 9768 3329
E: sales@iccons.com.au

NSW Branch

Unit 50, 317-321 Woodpark Road, Smithfield
New South Wales, 2164
P: 02 9757 3439
F: 02 9756 6587
E: salesnsw@iccons.com.au

QLD Branch

4/ 3375 Pacific Hwy, Slacks Creek, Queensland, 4127
P: 07 3290 5144
F: 07 3290 5166
E: salesqld@iccons.com.au

S.A Branch

15 Light Terrace, Thebarton, South Australia, 5031
P: 08 8234 5535
F: 08 8354 4689
E: salessa@iccons.com.au

W.A. Branch

90 Christable Way, Landsdale
Western Australia, 6065
P: 08 6305 0008
F: 08 6305 0011
E: saleswa@iccons.com.au

New Zealand

13D Paul Mathews Road, Albany, Auckland, 0632
P: TBA
F: TBA
E: TBA